

ERIS 05 7W

ERIS ROUND CLEAR GLASS COB DOWNLIGHT

Indoor Luminaire

Product Code:

LERS05R007XC / LERS05R007XN / LERS05R007XW

7W - 595lm - 6500K - CRI>90 - Beam Angle 33°



Technical Specifications

Operating Temperature	-10°C to 40°C
Rated Input Voltage & Frequency	230 VAC, 50Hz
Rated Input Wattage	7W ± 10%
Rated Input Current	0.030 Amp (Nominal)
Power Factor	≥0.90
THD	<15%
Rated Luminous Flux	595 lm / 560 lm / 525 lm (tolerance as per BIS)
Rated Luminaire Efficacy	85 lm/W / 80 lm/W / 75 lm/W (tolerance as per BIS)
Correlated Color Temperature (CCT)	6500 K / 4000 K / 3000 K (tolerance as per ANSI)
Color Rendering Index (CRI)	>90
Beam Angle	33°
Driver Efficiency	≥80%
LED Life Span	>50000 Hrs (Ta=25°C @L70)
Housing	Aluminium Housing with White/Black Powder Coating
Lens / Reflector	Reflector
Mounting	Recess

Protections

Over Voltage Protection	Withstand upto 440V/AC for 4 Hrs.
Surge Protection	±4.0KV
Protection Class	Class II
Ingress Protection (IP Rating)	IP20
Impact Protection (IK Rating)	IK02
Short Circuit Protection	Provided
Open Circuit Protection (No Load)	Provided
Reverse Polarity Protection	Provided

All technical data is subject to industry-standard tolerances.

Light Distribution

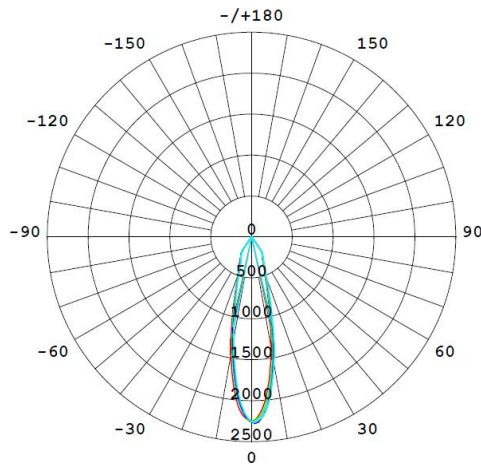

UGR Table

ceiling/cavity	0.7	0.7	0.5	0.5	0.3	0.7	0.7	0.5	0.5	0.3
walls	0.5	0.3	0.5	0.3	0.3	0.5	0.3	0.5	0.3	0.3
working plane	0.2	0.2	0.2	0.2	0.2	0.2	0.2	0.2	0.2	0.2
Room dimensions	Viewed crosswise					Viewed endwise				
x = 2H y = 2H	6.0	6.8	6.2	6.9	7.1	6.5	7.2	6.7	7.4	7.6
3H	5.9	6.6	6.1	6.8	7.0	6.4	7.1	6.6	7.3	7.5
4H	5.8	6.5	6.1	6.7	6.9	6.3	7.0	6.5	7.2	7.4
6H	5.7	6.4	6.0	6.6	6.8	6.2	6.8	6.5	7.1	7.3
8H	5.7	6.3	6.0	6.5	6.8	6.1	6.8	6.4	7.0	7.3
12H	5.6	6.2	5.9	6.5	6.8	6.1	6.7	6.4	7.0	7.2
4H 2H	5.8	6.5	6.1	6.7	6.9	6.3	6.9	6.5	7.2	7.4
3H	5.7	6.3	6.0	6.5	6.8	6.1	6.7	6.4	7.0	7.3
4H	5.6	6.1	5.9	6.4	6.7	6.0	6.6	6.4	6.9	7.2
6H	5.5	6.0	5.8	6.3	6.6	5.9	6.4	6.3	6.8	7.1
8H	5.4	5.9	5.8	6.2	6.6	5.9	6.3	6.3	6.7	7.0
12H	5.4	5.8	5.8	6.1	6.5	5.8	6.2	6.2	6.6	7.0
8H 4H	5.4	5.9	5.8	6.2	6.6	5.9	6.3	6.3	6.7	7.0
6H	5.3	5.7	5.7	6.1	6.5	5.8	6.2	6.2	6.5	7.0
8H	5.3	5.6	5.7	6.0	6.4	5.7	6.1	6.2	6.5	6.9
12H	5.2	5.5	5.7	5.9	6.4	5.7	5.9	6.1	6.4	6.9
12H 4H	5.4	5.8	5.8	6.1	6.5	5.8	6.2	6.2	6.6	7.0
6H	5.3	5.6	5.7	6.0	6.4	5.7	6.1	6.2	6.5	6.9
8H	5.2	5.5	5.7	5.9	6.4	5.7	5.9	6.1	6.4	6.9
Variations with the observer position at spacings(CIE Pub.117):										
S = 1.0H	+ 4.8 / - 5.5					+ 5.5 / - 9.0				
1.5H	+ 7.2 / - 5.2					+ 8.2 / - 8.3				
2.0H	+ 1.0 / - 1.1					+ 1.6 / - 1.5				

Product Dimensions (DiaxH)

Ø90 X 60mm (Tol. ± 5 mm), Cutout Dia . Ø80

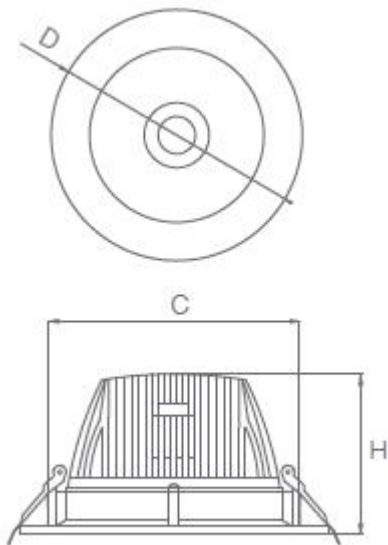

Applications

Residences, Offices, Small Retail Shops, Hotels, Coffee Shops, Restaurants, Hospitals, area lighting and for other indoor applications.